



**juice pack<sup>®</sup> connect &**  
**juice pack<sup>®</sup> connect mini**

---

USER MANUAL

1

a

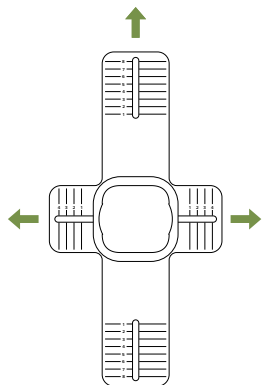
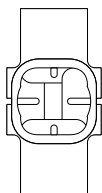

b

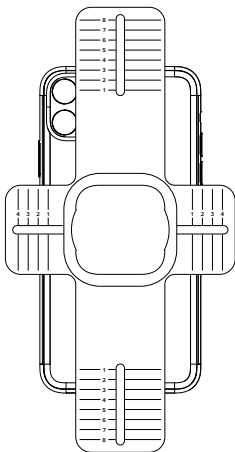

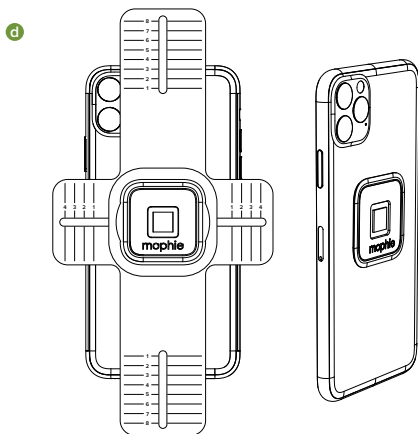
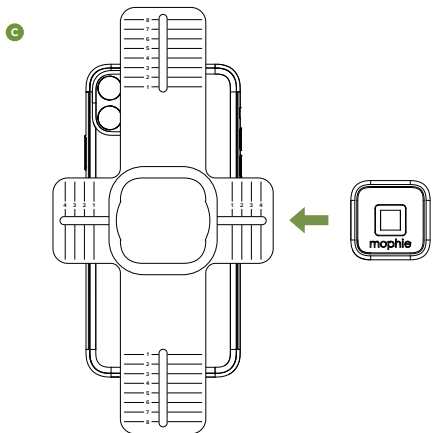

NOTE: Adapter is NOT readjustable. Please use the guide for a proper fit.

REMARQUE : L'adaptateur n'est PAS réajustable. Utilisez le guide pour une bonne pose.

2

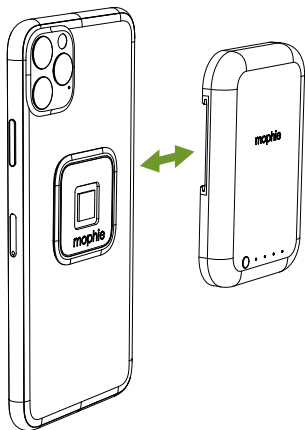

3

a

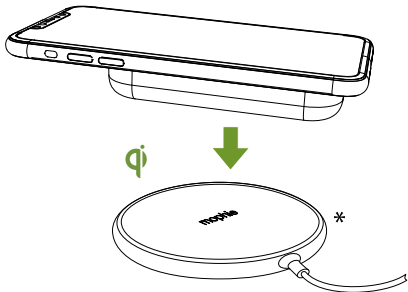

\*mophie wireless charging base not included

\*mophie wireless charging base non inclus

b

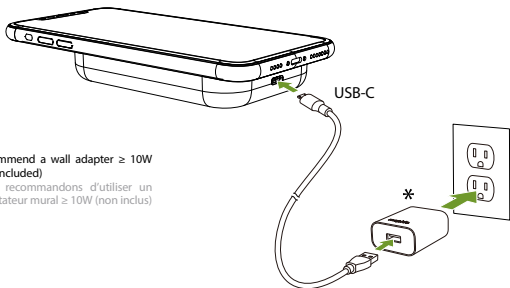
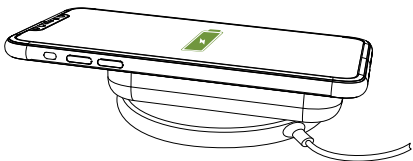

\*Recommend a wall adapter  $\geq 10W$   
(not included)

\*Nous recommandons d'utiliser un  
adaptateur mural  $\geq 10W$  (non inclus)

4



5

a

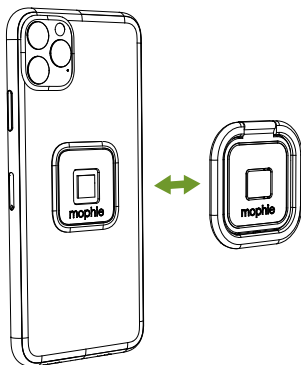

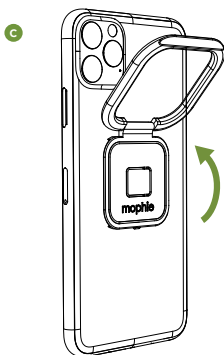
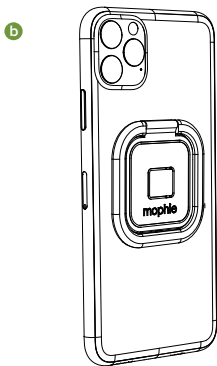

## **Warranty**

At mophie, we are dedicated to making the best quality products. To back this up, this product is warranted for 2 years. For full details regarding warranty terms, exclusions and limitations, please visit: [mophie.com/warranty](http://mophie.com/warranty). This warranty does not affect any statutory rights that you may be entitled to. Keep a copy of your purchase receipt as proof of purchase. Be sure to register your product at [mophie.com](http://mophie.com).

## **Customer Service**

Telephone: 1-888-8mophie (1-888-866-7443)

International: +1 (269) 743-1340

Web: [www.mophie.com/cs](http://www.mophie.com/cs)

## **IMPORTANT SAFETY INSTRUCTIONS**









### **WARNING**

Read all instructions and warnings prior to using this product. Improper use of this product may result in product damage, excess heat, toxic fumes, fire or explosion, for which damages you (“Purchaser”), and not mophie llc (“Manufacturer”) are responsible.







- ☠ Before using your juice pack connect portable battery for the first time, fully charge it (so that pressing the charge status button lights all 4



status LEDs).

-  Do not store device in high-temperature environment, including heat caused by intense sunlight or other forms of heat. Do not place device in fire or other excessively hot environments. Exposure to fire or temperature above 212°F (100°C) may cause explosion.
-  This product should be operated only in open-air conditions. It should not be operated in an enclosed, unventilated space such as a carrying bag, pocket, purse or bedding. Failure to follow these instructions may damage the product by overheating.
-  Do not disconnect the juice pack battery from a connected device while the device is charging—wait until the device is fully charged.
-  Be cautious of drops, bumps, abrasions, or other impacts to this device. If there is any damage to the device such as dents, punctures, tears, deformities, or corrosion due to any cause, discontinue use. Contact Manufacturer or dispose of it in an appropriate manner at your local battery-recycling center.
-  Do not expose the battery case to rain or snow.
-  Do not put fingers or hands into the product.
-  Do not disassemble this device or attempt to re-purpose or modify it in any manner.
-  For questions or instructions for the various

ways to charge this device, refer to the illustrations in this quick-start guide.

-  Use of a power supply or charger not recommended or included by mophie may result in a risk of fire or injury to persons.
-  Do not use the battery case in excess of its output rating. Overloading outputs above rating may result in a risk of fire or injury to persons.
-  Do not attempt to replace any part of this device.
-  If this device is accessible to or may be used by a minor, purchasing adult agrees to be solely responsible for providing supervision, instruction, and warnings. Purchaser agrees to defend, indemnify, and hold Manufacturer harmless for any claims or damages arising from unintended use or misuse by a minor.
-  All products have gone through a thorough quality assurance inspection. If you find that your device is excessively hot, is emitting odor, is deformed, abraded, cut or is experiencing or demonstrating an abnormal phenomenon, immediately stop all product use and contact Manufacturer.
-  Never dispose of batteries in the garbage. Disposal of batteries in the garbage is unlawful under state and federal environmental laws and regulations. Always take used batteries to

- your local battery-recycling center.
- X-0 Switch off the portable battery when not in use. The portable battery will automatically switch off when disconnected from a device.
  - X-0 To comply with FCC/IC RF exposure compliance requirements, the wireless charger must be used with a separation distance of at least 10 cm from all persons.
  - X-0 This device has been evaluated to meet general RF exposure requirement. The device can be used in portable exposure condition without restriction.
  - X-0 Any changes or modifications not expressly approved by the party responsible for compliance could void the user's authority to operate the equipment.

## **SAVE THESE INSTRUCTIONS**

### **Legal**

Manufacturer shall not in any way be liable to you or to any third party for any damages you or any third party may suffer as a result of use, intended or unintended, or misuse of this product in conjunction with any device or accessory other than the appropriate device for which this product is designed. Manufacturer will not be responsible for any damages you or any third party may suffer as a result of misuse of this product as outlined above.

Purchaser agrees to defend, indemnify, and hold Manufacturer harmless for any claims or damages arising from unintended use or misuse, including use with an unintended device.

This device complies with part 15 of the FCC Rules and RSS-Gen of IC Rules. Operation is subject to the following two conditions: (1) This device may not cause harmful interference, and (2) this device must accept any interference received, including interference that may cause undesired operation.

NOTE: This equipment has been tested and found to comply with the limits for a Class B digital device, pursuant to part 15 of the FCC Rules. These limits are designed to provide reasonable protection against harmful interference in a residential installation. This equipment generates, uses, and can radiate radio frequency energy and, if not installed and used in accordance with the instructions, may cause harmful interference to radio communications. However, there is no guarantee that interference will not occur in a particular installation.

If this equipment does cause harmful interference to radio or television reception, which can be determined by turning the equipment off and on, the user is encouraged to try to correct the interference by one or more of the following measures:

- Reorient or relocate the receiving antenna.
- Increase the separation between the equipment and receiver.
- Connect the equipment into an outlet on a circuit different from that to which the receiver is connected.
- Consult the dealer or an experienced technician for help.

**CAUTION:** To comply with the limits of the Class B digital device, pursuant to Part 15 of the FCC Rules, this device must be used with certified peripherals and shielded cables. All peripherals must be shielded and grounded. Operation with non-certified peripherals or non-shielded cables may result in interference to radio or reception.

**MODIFICATION:** Any changes or modifications of this device could void the warranty.

#### STATEMENT OF COMPLIANCE

Hereby, ZAGG International declares that the radio equipment wireless charging base is in compliance with Directive 2014/53/EU. The full text of the EU declaration of conformity is available at the following internet address: [http://www.mophie.com/cert\\_red](http://www.mophie.com/cert_red).



#### WEEE STATEMENT:

All of our products are marked with the WEEE symbol; this indicates that this product must NOT be disposed of with other waste. Instead it is the user's responsibility to dispose of their waste electrical and electronic equipment by handing it over to an approved re-processor, or by returning it to mophie inc. for reprocessing. For more information about where you can send your waste equipment for recycling, please contact mophie, inc. or one of your local distributors.

THIS DEVICE CONFORMS TO UL STD. 60950-1. CERTIFIED TO CSA STD. C22.2 NO. 60950-1. CONFORMS TO UL SUBJECT 2056.



### **Customer Service**

Telephone: 1-888-8mophie (1-888-866-7443)

International: +1 (269) 743-1340

Web: [www.mophie.com/cs](http://www.mophie.com/cs)

mophie, juice pack, Stay Powerful, and the mophie logo are trademarks of mophie inc. . Qi and the Qi logo are trademarks of the Wireless Power Consortium. USB-C is a trademark of USB Implementers Forum. All rights reserved.

Patents: [mophie.com/patents](http://mophie.com/patents)

© 2020 mophie inc.